



**LED Pilot Lamp,
Push Button,
Selector Switch**



16 φ m/m ILLUMINATED PUSH BUTTON SWITCHES, IP40 & IP60

Type	Voltage	No. of Contact	Lense
AL-Alternative	110V AC (LED)	1a1b (1NO 1NC)	Red
ML-Reset	220V AC (LED)	2a2b (2NO 2NC)	Orange
PL-Indicate	6V DC (LED)	1a (1NO)	Green
BK-Push Lock (24 φ)	24V DC (LED)	1b (1NC)	White
BKL-Push Lock (30 φ)	12V DC (LED)		Blue

TT16-ALR
TT16-MLR

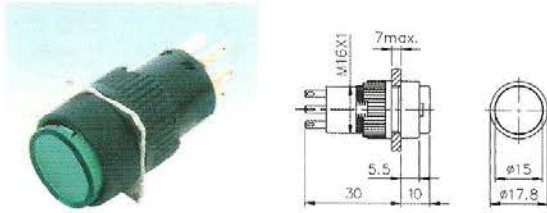

TT16-PLR

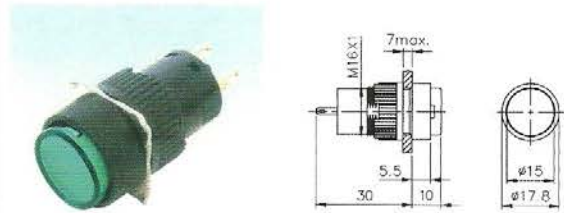

TT16-ALS
TT16-MLS

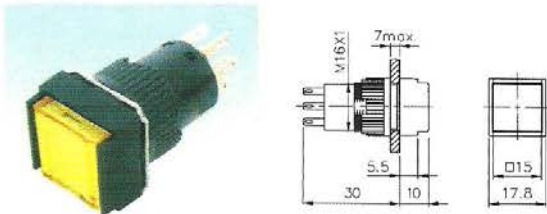

TT16-PLS

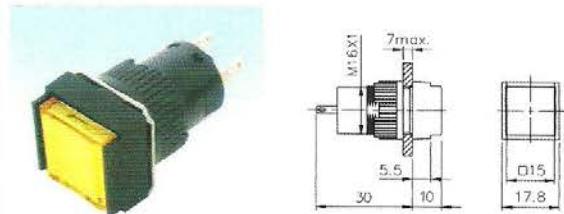

TT16-ALL

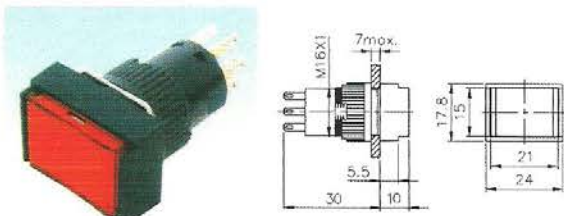

TT16-PLL

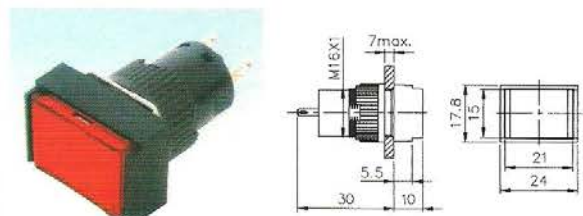

TT16-BKR

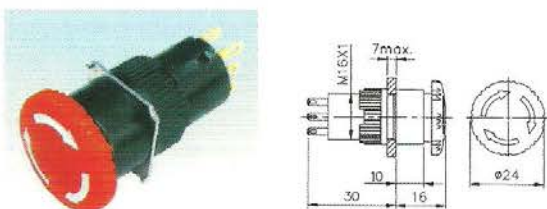

TT16-BLKR

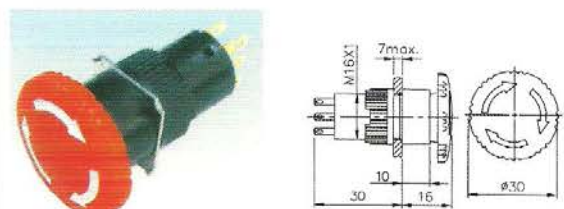



Type	Position	No. of Contact	Lense
SS-Selector	2 Position 90°	1a1b (1NO 1NC)	Red
KS-Key Selector	2 Position 90°(reset)	2a2b (2NO 2NC)	Green
R-Round	3 Position 90°	1a1b 0 1a1b	Blue
S-Square	2 Position 90°(reset)	1a1b 0 1a1b	
L-Long Square			

Method of draw out the ker.

2 position



3 position

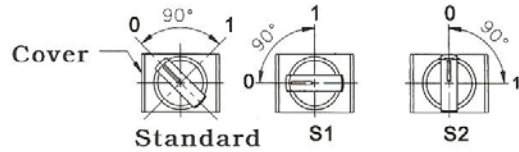
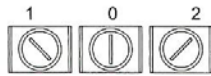

TT16-SSR

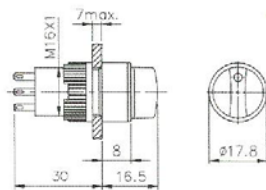

TT16-KSR

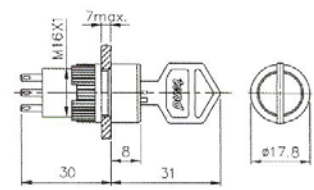

TT16-SSS

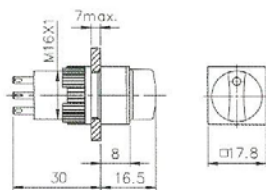

TT16-KSS

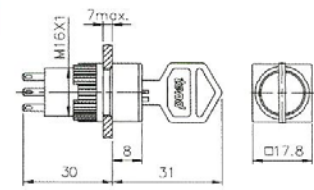
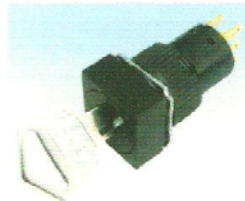

TT16-SSL

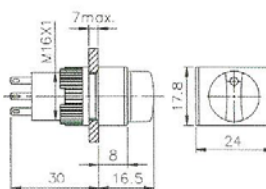

TT16-KSL

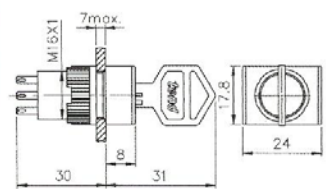



Type	Voltage Rating	Lens Color	Blues
NPL-Change type	AC. DC 24V	Red	LED
NLD-Fixed type	AC. DC 100-120V	Green	LED
ANPL-Direct type	AC. DC 220-240V	Yellow	Neon
ATPL-Transformer type	AC 380-440V AC 110V-120V DC 220V DC 24V	Blue White	Filament

NPL22-R,G,Y

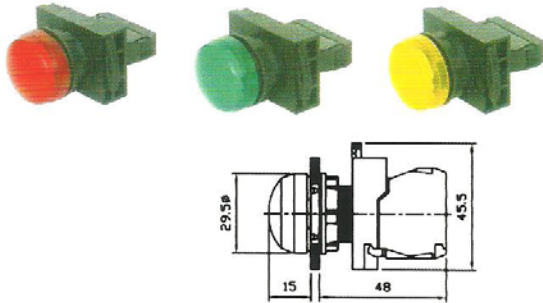

NLD22-R,G,Y

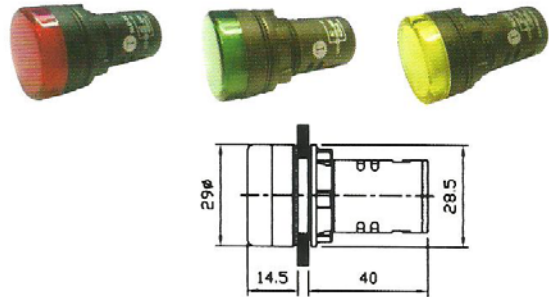

ANPL-22

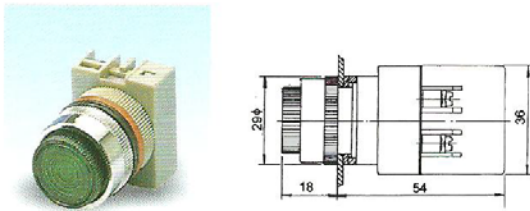

ATPL-22

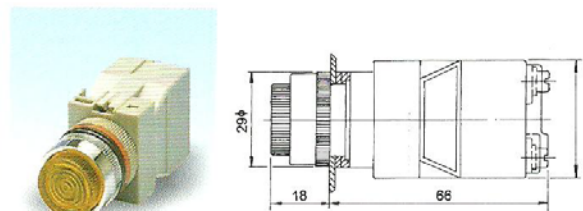

NPL-22

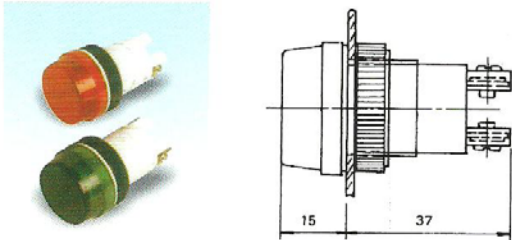

SNPL-22

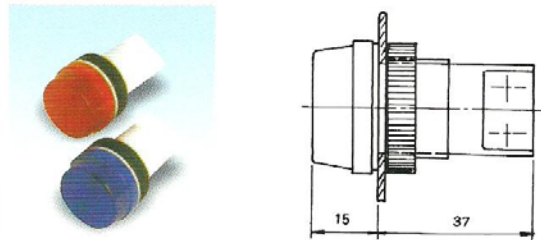

SRNLR-25

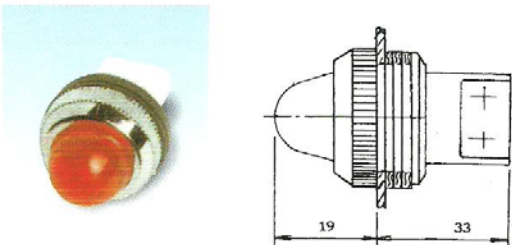

NPLR-25

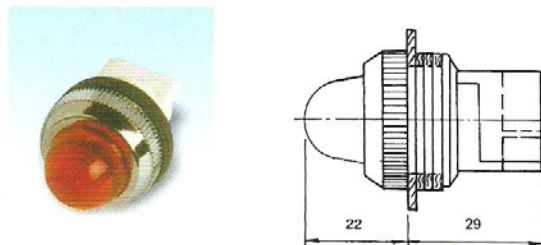



10φ/12φ/16φ NEON PILOT LAMP

PL-1601, 16φ

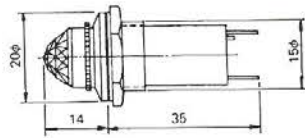

PL-1001, 10φ

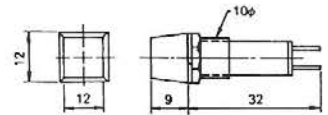

PL-1602, 16φ

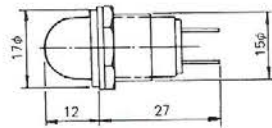

PL-1002, 10φ

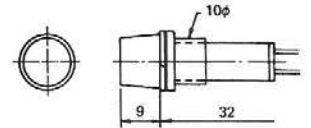

PL-1603, 16φ

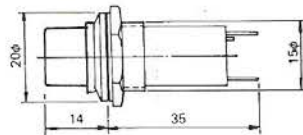

PL-1004, 10φ

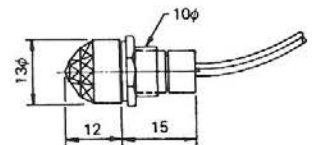

PL-1604, 16φ

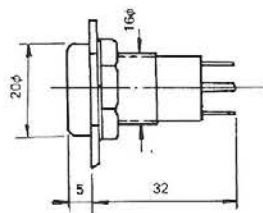

PL-1005, 10φ

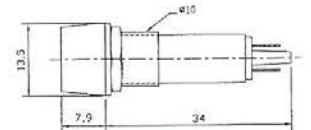

PL-1605, 16φ

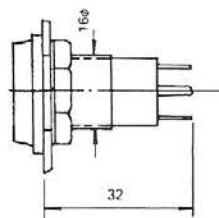

NPL-12, 12φ

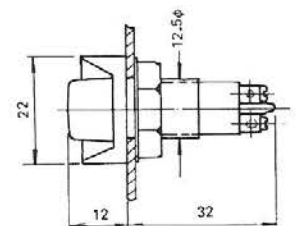



DOUBLE PUSH BUTTON, 22mm, 25mm, 30mm

NLB22-D ILLUMINATED

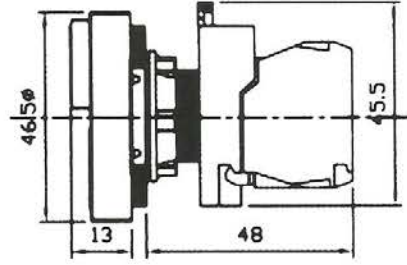
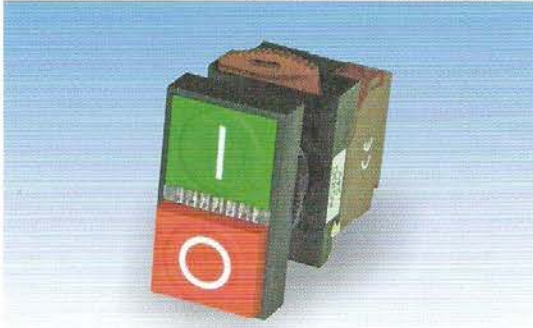

NPB22-D

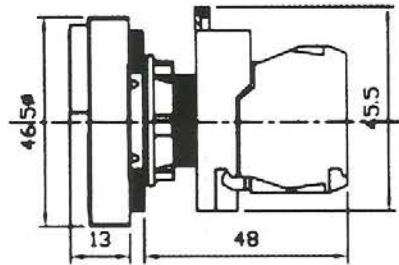
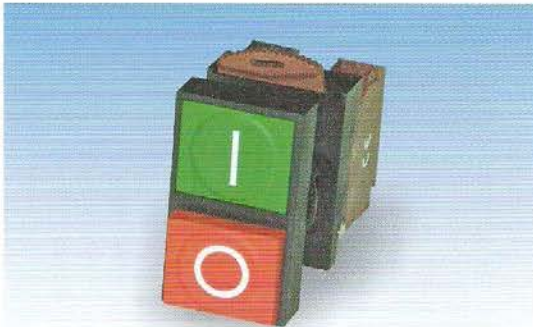

T2ITL ILLUMINATED

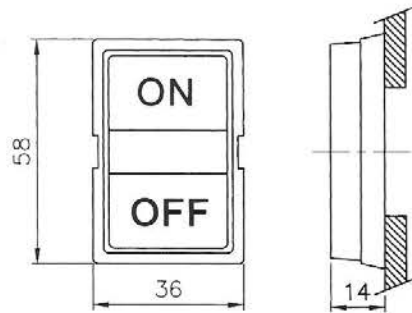
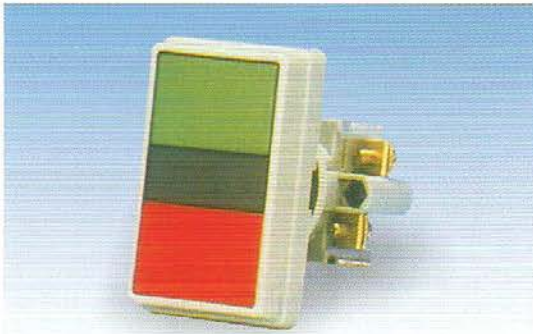

T3ITL ILLUMINATED

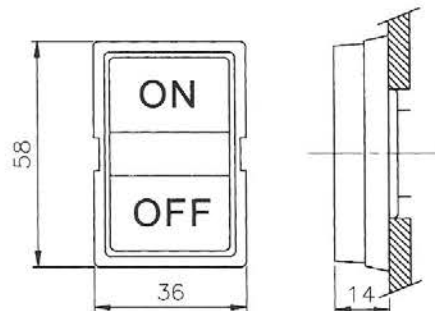



SELECTOR SWITCH 22mm, 25mm, 30mm



ASS-290 (90° - 2 Position)

<p>90° - 2 Position</p>	1 N/O	ASS-290-10
	1 N/C	ASS-290-1C
	1N/O+1N/C	ASS-290-10/C
	2 N/O	ASS-290-20
	2 N/C	ASS-290-2C
	2N/O+2N/C	ASS-290-20/C

ASS-245 (45° - 3 Position)

<p>45° - 3 Position</p>	1 N/O	ASS-245-10
	1 N/C	ASS-245-1C
	1N/O+1N/C	ASS-245-10/C
	2 N/O	ASS-245-20
	2 N/C	ASS-245-2C
	2N/O+2N/C	ASS-245-20/C



ASS-290 (90° - 2 Position)

<p>90° - 2 Position</p>	1 N/O	ALSS-290-10
	1 N/C	ALSS-290-1C
	1N/O+1N/C	ALSS-290-10/C
	2 N/O	ALSS-290-20
	2 N/C	ALSS-290-2C
	2N/O+2N/C	ALSS-290-20/C

ASS-245 (45° - 3 Position)

<p>45° - 3 Position</p>	1 N/O	ALSS-245-10
	1 N/C	ALSS-245-1C
	1N/O+1N/C	ALSS-245-10/C
	2 N/O	ALSS-245-20
	2 N/C	ALSS-245-2C
	2N/O+2N/C	ALSS-245-20/C

NSS-22-S2 (90° - 2 Position)

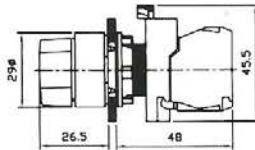

NSS-22-S2 (45° - 3 Position)

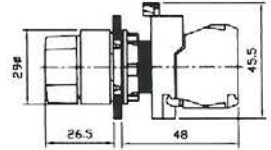

NSS-22-L2 (90° - 2 Position)

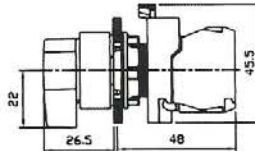

NSS-22-L2 (45° - 3 Position)

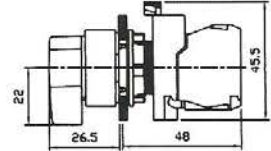

ISS-90 ILLUMINATED (90° - 2 Position)



<p>90° 2 Position</p>	1 N/O	ISS-290-10	R : Red G : Green Y : Yellow
	1 N/C	ISS-290-1C	
	1N/O+1N/C	ISS-290-10/C	
	2 N/O	ISS-290-20	
	2 N/C	ISS-290-2C	
	2N/O+2N/C	ISS-290-20/C	

ISS-245 ILLUMINATED (45° - 3 Position)

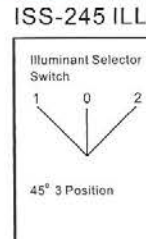

<p>45° 3 Position</p>	1 N/O	ISS-245-10	R : Red G : Green Y : Yellow
	1 N/C	ISS-245-1C	
	1N/O+1N/C	ISS-245-10/C	
	2 N/O	ISS-245-20	
	2 N/C	ISS-245-2C	
	2N/O+2N/C	ISS-245-20/C	

NLS-22 ILLUMINATED (90° - 2 Position)

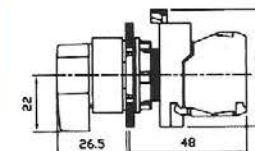

NLSS-22 ILLUMINATED (45° - 3 Position)

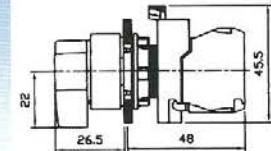



EMERGENCY PUSH BUTTON SWITCH - 22 ϕ / 25 ϕ / 30 ϕ

ALEPB-22 (Push Lock. Mushroom 40mm)

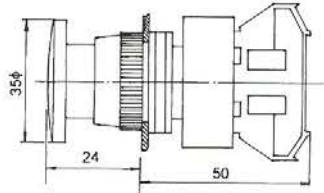

- ALEPB-22-1O (1N/O)
- ALEPB-22-1C (1N/C)
- ALEPB-22-1O (1N/O+1N/C)
- ALEPB-22-2O (2N/O)
- ALEPB-22-2C (2N/C)
- ALEPB-22-2N/C (2N/O+2N/C)

NPB-22-R

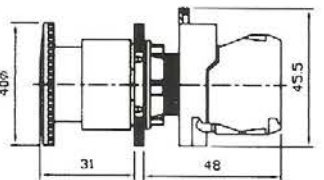

- NPB-22-1O (1N/O)
- NPB-22-1C (1N/C)
- NPB-22-1O/C (1N/O+1N/C)
- NPB-22-2O (2N/O)
- NPB-22-2C (2N/C)
- NPB-22-2N/C (2N/O+2N/C)

NLB-22-R ILLUMINATED

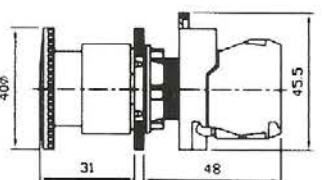

- NLB-22-R-1O (1N/O)
- NLB-22-R-1C (1N/C)
- NLB-22-R-1O/C (1N/O+1N/C)
- NLB-22-R-2O (2N/O)
- NLB-22-R-2C (2N/C)
- NLB-22-R-2N/C (2N/O+2N/C)

T2IKR ILLUMINATED PUSH LOCK

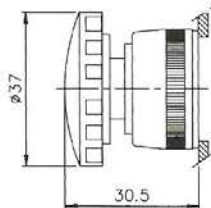

- T2IKR-1O (1N/O)
- T2IKR-1C (1N/C)
- T2IKR-1O/C (1N/O+1N/C)
- T2IKR-2O (2N/O)
- T2IKR-2C (2N/C)
- T2IKR-2N/C (2N/O+2N/C)

T3IKR ILLUMINATED PUSH LOCK

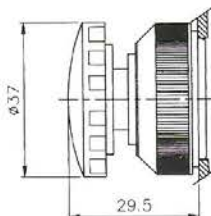

- T3IKR-1O (1N/O)
- T3IKR-1C (1N/C)
- T3IKR-1O (1N/O+1N/C)
- T3IKR-2O (2N/O)
- T3IKR-2C (2N/C)
- T3IKR-2N/C (2N/O+2N/C)

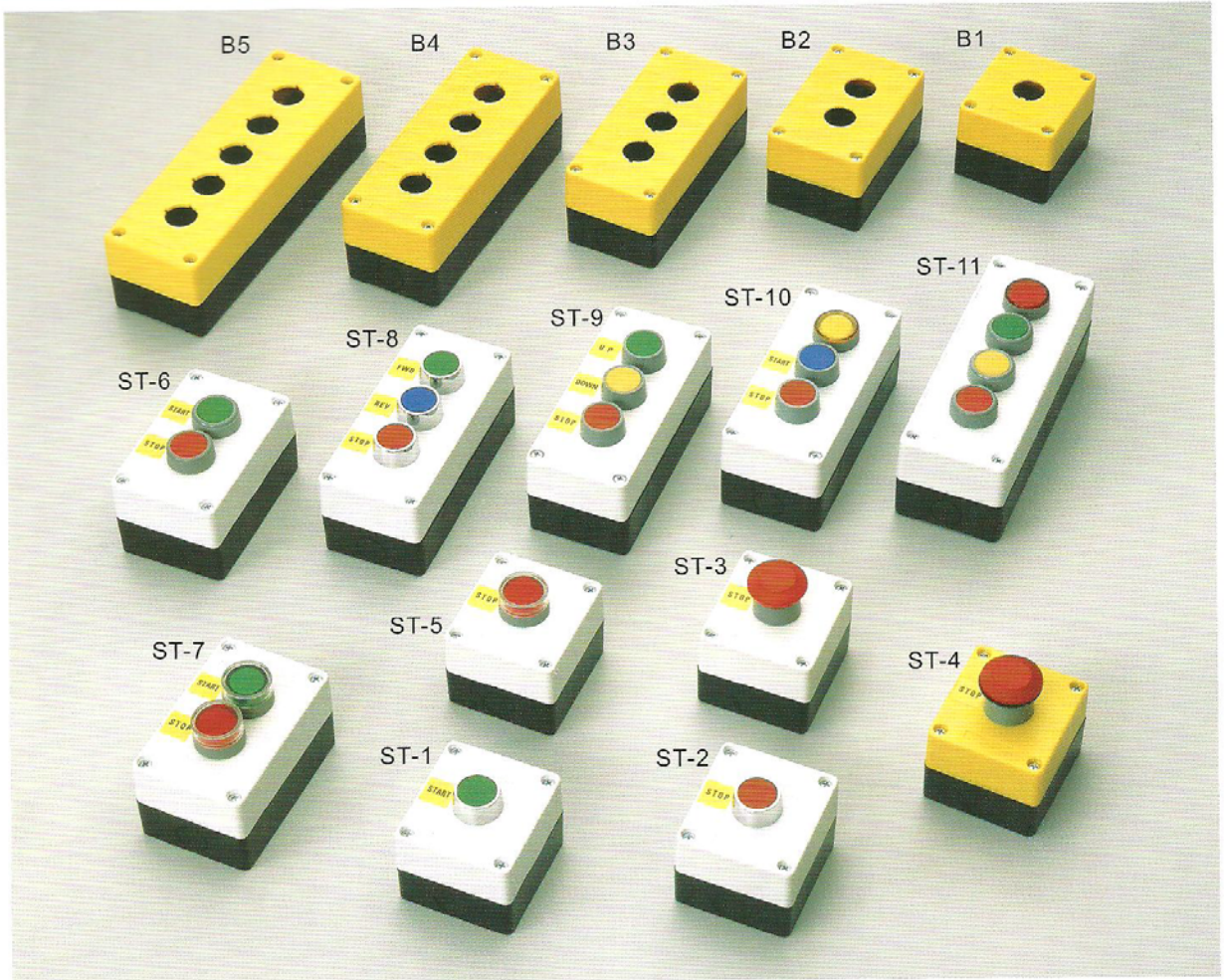

ST-1	1 pushbutton "START"		ST-7	2 illuminated pushbutton with neon lamp "START" "STOP"	
ST-2	1 pushbutton "STOP"		ST-8	3 pushbuttons "FORWARD" "REVERSE" "STOP"	
ST-3	1 mushroom Head pushbutton.		ST-9	3 pushbuttons "UP" "DOWN" "STOP"	
ST-4	1 Latching mushroom head pushbutton "STOP"		ST-10	1 red pilot light with neon lamp "START" 2 pushbuttons "STOP"	
ST-5	1 illuminated push button with neon lamp "STOP"		ST-11	3 illuminated push button with neon lamp	
ST-6	2 pushbutton "START" "STOP"				

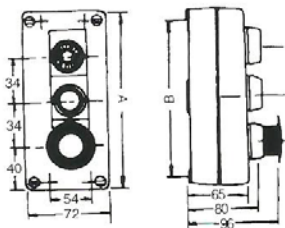

	A	B
1 Button	78	67
2 Button	111	89
3 Button	151	130
4 Button	185	150
5 Button	222	184