



TAIWAN METERS
TAIWAN SAFETY CONTROLS

Din Rail Terminal, Din Rail



RAIL - MOUNT TERMINALS (Polyamide 66)

HT-2.5



Qty. p. pok. (g/pcs)	1320 / 200
Terminal width	5.1 mm
Insulation stripping length	7 mm
Solid	0.2 - 4
Stranded	0.2 - 2.5
AWG	22 - 12

HT-4

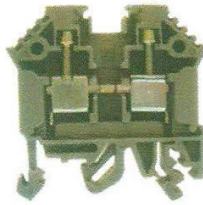

Qty. p. pok. (g/pcs)	1100 / 100
Terminal width	6.2 mm
Insulation stripping length	11.5 mm
Solid	0.2 - 6
Stranded	0.2 - 4
AWG	22 - 10

HT-10

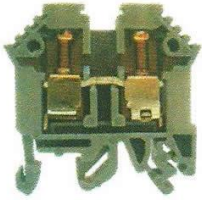

Qty. p. pok. (g/pcs)	1630 / 100
Terminal width	8.4 mm
Insulation stripping length	12 mm
Solid	0.2 - 10
Stranded	0.2 - 10
AWG	22 - 8

HT-16

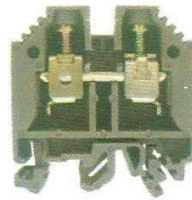

Qty. p. pok. (g/pcs)	1480 / 50
Terminal width	12.3 mm
Insulation stripping length	15 mm
Solid	2.5 - 25
Stranded	2.5 - 16
AWG	12 - 6

HT-35

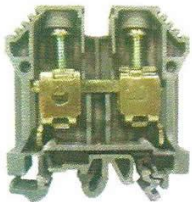

Qty. p. pok. (g/pcs)	1156 / 20
Terminal width	16.2 mm
Insulation stripping length	18 mm
Solid	2.5 - 50
Stranded	2.5 - 35
AWG	12 - 2

HT-50

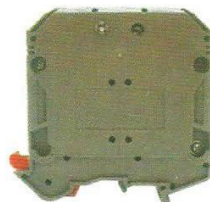

Qty. p. pok. (g/pcs)	5835 / 50
Terminal width	20.3 mm
Insulation stripping length	27 mm
Solid	16 - 50
Stranded	25 - 50
AWG	6 - 1/0

HT-95



Qty. p. pok. (g/pcs)	4695 / 25
Terminal width	25.5 mm
Insulation stripping length	30 mm
Solid	35 - 95
Stranded	35 - 95
AWG	2

EP-4 / EP-16 / EP-35 (End Stops)

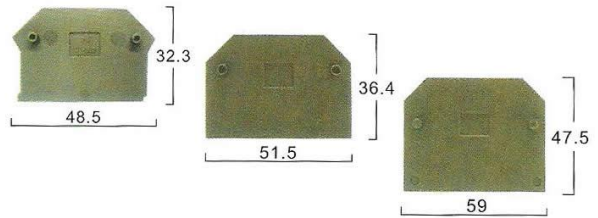

HT-4E

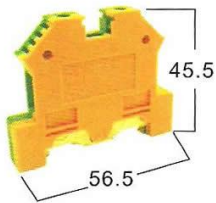

Qty. p. pok. (g/pcs)	1540 / 50
Terminal width	9 mm
Insulation stripping length	11.5 mm
Solid	0.2 - 6
Stranded	0.2 - 4
AWG	22 - 10

HT-10E

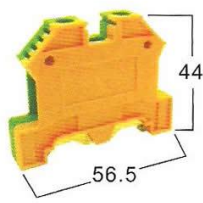

Qty. p. pok. (g/pcs)	1680 / 50
Terminal width	10.4 mm
Insulation stripping length	12 mm
Solid	0.2 - 10
Stranded	0.2 - 10
AWG	20 - 6

HT-16E

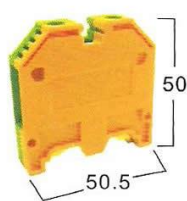

Qty. p. pok. (g/pcs)	1072 / 20
Terminal width	12 mm
Insulation stripping length	12 mm
Solid	2.5 - 25
Stranded	2.5 - 16
AWG	10

HT-35E

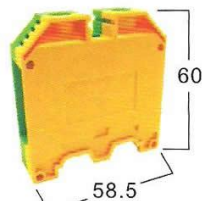

Qty. p. pok. (g/pcs)	2020 / 20
Terminal width	16 mm
Insulation stripping length	18 mm
Solid	2.5 - 50
Stranded	2.5 - 35
AWG	10



SOLID - TYPE TERMINAL BLOCK

FEATURES

TB-25 and TB-10 TB-20 Series: glass reinforced plastic ensures heat-resistance, good toughness and no crack.

TB25-3

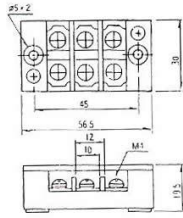

TB25-4

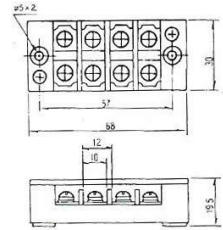

TB25-6

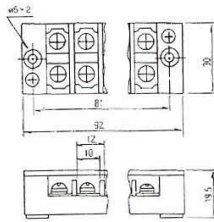
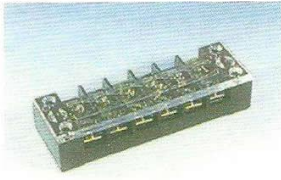

TB25-12

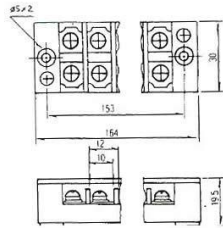
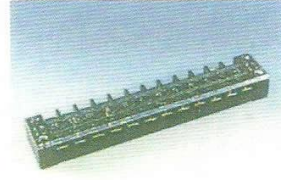

TB-10

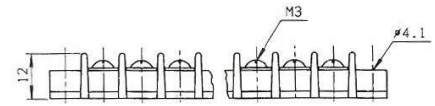
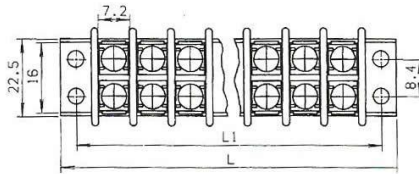
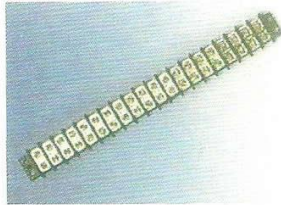

NO. OF POLES	1	2	3	4	5	6	7	8	9	10	11	12	13
L1	19	28.5	38	47.5	57	66.5	76	85.5	95	104.5	114	123.5	133
L	26.2	35.7	45.2	54.7	64.2	73.7	83.2	92.7	102.2	111.7	121.2	130.7	140.2

NO. OF POLES	14	15	16	17	18	19	20	21	22	23	24	25	26
L1	142.5	152	161.5	171	180.5	190	199.5	209	218.5	228	237.5	247	256.5
L	149.7	159.2	168.7	178.2	187.7	197.2	206.7	216.2	225.7	235.2	244.7	254.2	263.7

TB-20

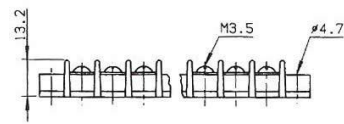
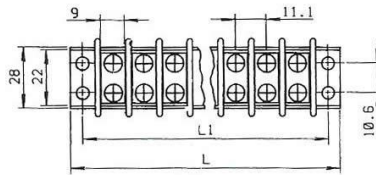
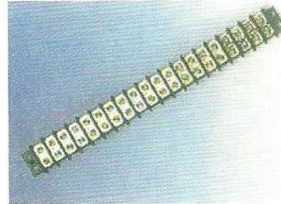

NO. OF POLES	1	2	3	4	5	6	7	8	9	10	11	12	13
L	31.2	42.3	53.4	64.5	75.6	86.7	97.8	108.9	120	131.1	142.2	153.3	164.4
L1	22.2	33.3	44.4	55.5	66.6	77.7	88.8	99.9	111	122.1	133.2	144.3	155.4

NO. OF POLES	14	15	16	17	18	19	20	21	22	23	24	25	26
L	175.5	186.6	197.7	208.8	219.9	231	242.1	253.2	264.3	275.4	286.5	297.6	308.7
L1	166.5	177.6	188.7	199.8	210.9	222	233.1	244.2	255.3	266.4	277.5	288.6	299.7

TT10-24

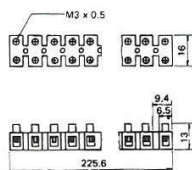

TBR-N (DIN Rail)

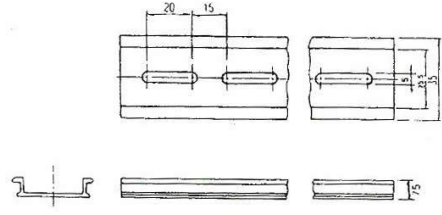
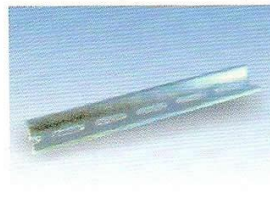



TERMINAL BLOCK

TB-60A

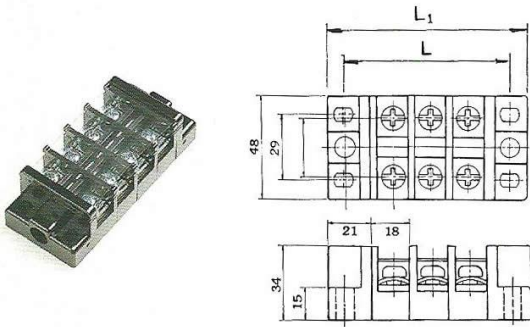

No. of Pole	3	4	5	6	7	8	9	10
L	82	100	118	136	154	172	190	208
L1	95	113	131	149	167	185	203	221

TB-100A

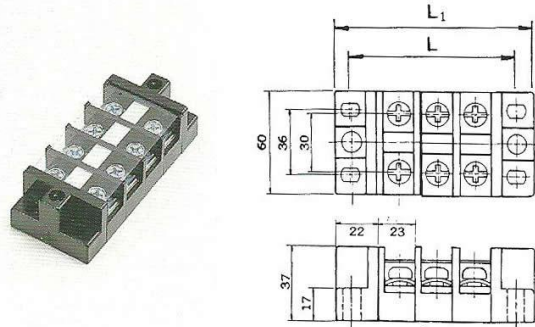

No. of Pole	3	4	5	6	7	8	9	10
L	95	118	141	164	187	210	233	256
L1	112	135	158	181	204	227	250	273

TB-200A

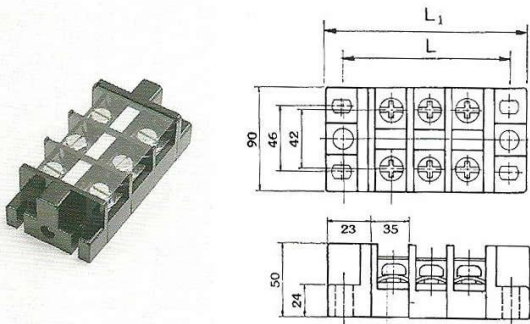

No. of Pole	3	4	5	6	7	8	9	10
L	131	166	201	236	271	306	341	376
L1	151	186	221	256	291	326	361	396

TB-300A

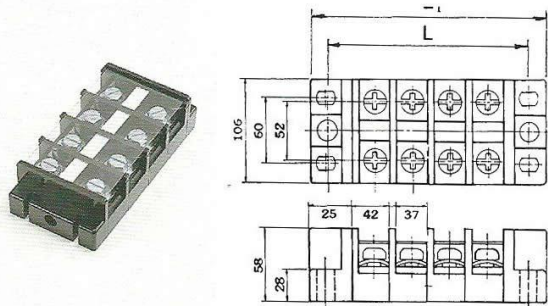

No. of Pole	3	4	5	6	7	8	9	10
L	156	198	240	282	324	346		
L1	176	218	260	302	344	386		

TB-400A

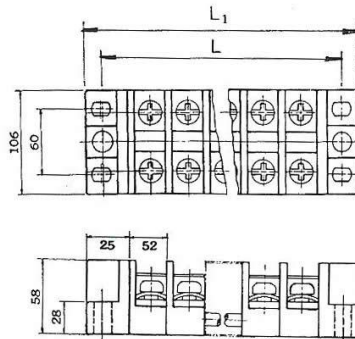
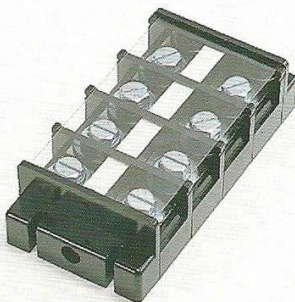

No. of Pole	3	4	5	6	7	8	9	10
L	186	238	290	342	394	446		
L1	206	258	310	362	414	466		